

# NEVA/PARIS

## FRONT PLATE

### FACE AVANT

#### Description

Material : full brass.

Windows opening : 2 modules + 1 round for PB (E).

Button: round button.

Silicone: to reduce sound impact between buttons and face plate.

POSITION

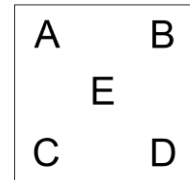

#### Caractéristiques

Matière : laiton massif.

Fenêtre : 2 modules + 1 ouverture ronde pour BP (E).

Bouton: bouton rond.

Silicone : réduit l'impacte du son entre le bouton et la face avant.

Ref.	Finish	Finition	Effect	Effet
PPA046LMH	Polished mirror brass	Laiton miroir	Shiny	Brillant
PPA046LBH	Brushed brass	Laiton brossé	Matt	Mat
PPA046LSH	Microbilled/satin brass	Laiton microbillé	Satin	Satin
PPA046VOH	Antique/old gold	Vieil or	Matt	Mat
PPA046BMH	Medium bronze	Bronze moyen	Matt	Mat
PPA046BRH	Dark bronze	Bronze noir	Shiny	Brillant
PPA046BZH	Grey bronze	Bronze gris	Matt	Mat
PPA046NMH	Polished mirror nickel	Nickel miroir	Shiny	Brillant
PPA046NBH	Brushed nickel	Nickel brossé	Matt	Mat
PPA046NSH	Microbilled/satin nickel	Nickel brossé	Matt	Mat
PPA046CHH	Polished mirror chrome	Chrome miroir	Shiny	Brillant
PPA046ROH	Brushed copper	Cuivre brossé	Matt	Mat
PPA046RAH	RAL code 9003	RAL codes 9003	Matt	Mat
PPA046ORH	24K gold	24K or	Shiny	Brillant
PPA046OMH	24K microbilled gold	microbillé 24K or	Satin	Satin

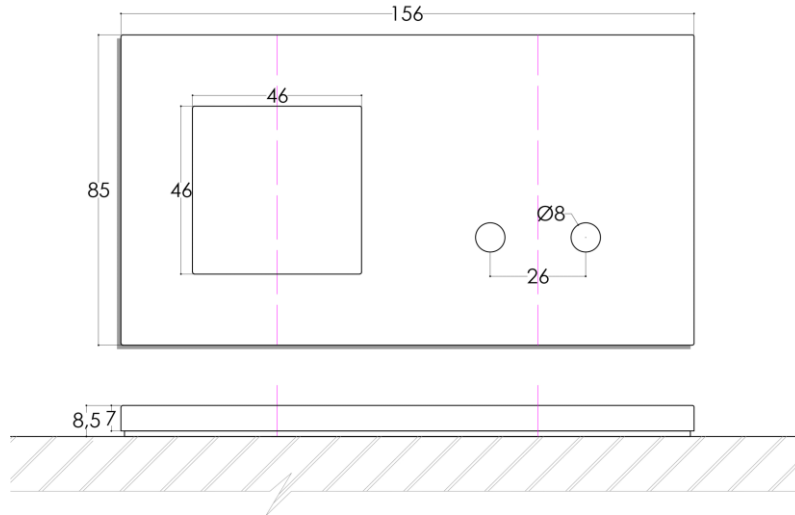

# NEVA/PARIS

## FRONT PLATE

### FACE AVANT

#### Description

Material : full brass.

Windows opening : 2 modules + 2 round holes for PB (CD).

Button: round buttons.

Silicone: to reduce sound impact between buttons and face plate.

POSITION

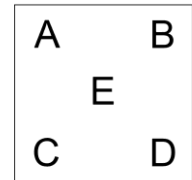

#### Caractéristiques

Matière : laiton massif.

Fenêtre : 2 modules + 2 ouvertures rondes pour BP (CD).

Bouton: boutons ronds.

Silicone : réduit l'impacte du son entre le bouton et la face avant.

Ref.	Finish	Finition	Effect	Effet
PPA051LMH	Polished mirror brass	Laiton miroir	Shiny	Brillant
PPA051LBH	Brushed brass	Laiton brossé	Matt	Mat
PPA051LSH	Microbilled/satin brass	Laiton microbillé	Satin	Satin
PPA051VOH	Antique/old gold	Vieil or	Matt	Mat
PPA051BMH	Medium bronze	Bronze moyen	Matt	Mat
PPA051BRH	Dark bronze	Bronze noir	Shiny	Brillant
PPA051BZH	Grey bronze	Bronze gris	Matt	Mat
PPA051NMH	Polished mirror nickel	Nickel miroir	Shiny	Brillant
PPA051NBH	Brushed nickel	Nickel brossé	Matt	Mat
PPA051NSH	Microbilled/satin nickel	Nickel brossé	Matt	Mat
PPA051CHH	Polished mirror chrome	Chrome miroir	Shiny	Brillant
PPA051ROH	Brushed copper	Cuivre brossé	Matt	Mat
PPA051RAH	RAL code 9003	RAL codes 9003	Matt	Mat
PPA051ORH	24K gold	24K or	Shiny	Brillant
PPA051OMH	24K microbilled gold	microbillé 24K or	Satin	Satin

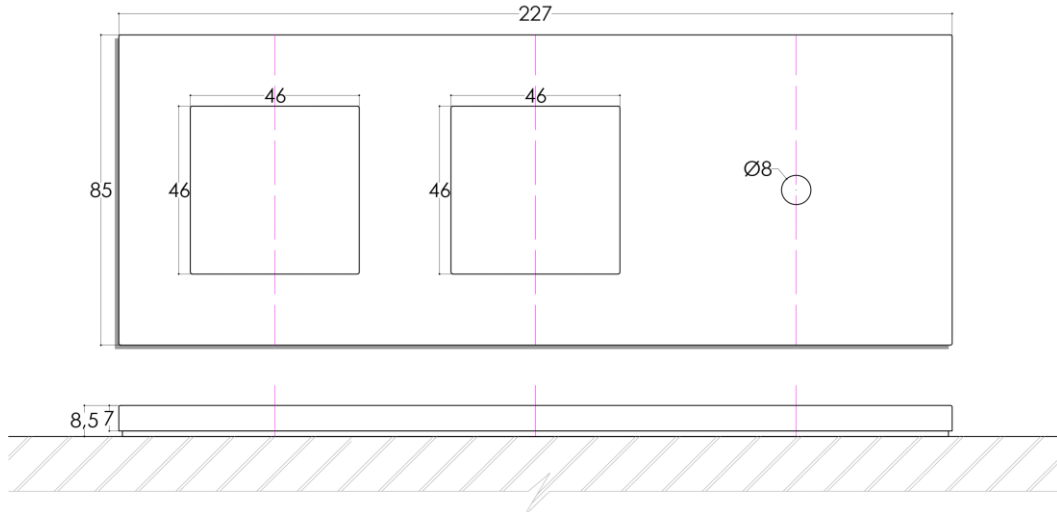

# NEVA/PARIS

## FRONT PLATE FACE AVANT

### Description

Material : full brass.

Windows opening : 2 modules + 2 modules + 1 round hole for PB (E).

Button: round button.

Silicone: to reduce sound impact between buttons and face plate.

### POSITION

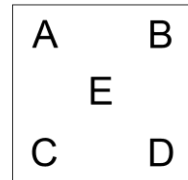

### Caractéristiques

Matière : laiton massif.

Fenêtre : 2 modules + 2 modules + 1 ouverture ronde pour BP (E).

Bouton: bouton rond.

Silicone : réduit l'impacte du son entre le bouton et la face avant.

Ref.	Finish	Finition	Effect	Effet
PPA126LMH	Polished mirror brass	Laiton miroir	Shiny	Brillant
PPA126LBH	Brushed brass	Laiton brossé	Matt	Mat
PPA126LSH	Microbilled/satin brass	Laiton microbillé	Satin	Satin
PPA126VOH	Antique/old gold	Vieil or	Matt	Mat
PPA126BMH	Medium bronze	Bronze moyen	Matt	Mat
PPA126BRH	Dark bronze	Bronze noir	Shiny	Brillant
PPA126BZH	Grey bronze	Bronze gris	Matt	Mat
PPA126NMH	Polished mirror nickel	Nickel miroir	Shiny	Brillant
PPA126NBH	Brushed nickel	Nickel brossé	Matt	Mat
PPA126NSH	Microbilled/satin nickel	Nickel brossé	Matt	Mat
PPA126CHH	Polished mirror chrome	Chrome miroir	Shiny	Brillant
PPA126ROH	Brushed copper	Cuivre brossé	Matt	Mat
PPA126RAH	RAL code 9003	RAL codes 9003	Matt	Mat
PPA126ORH	24K gold	24K or	Shiny	Brillant
PPA126OMH	24K microbilled gold	microbillé 24K or	Satin	Satin

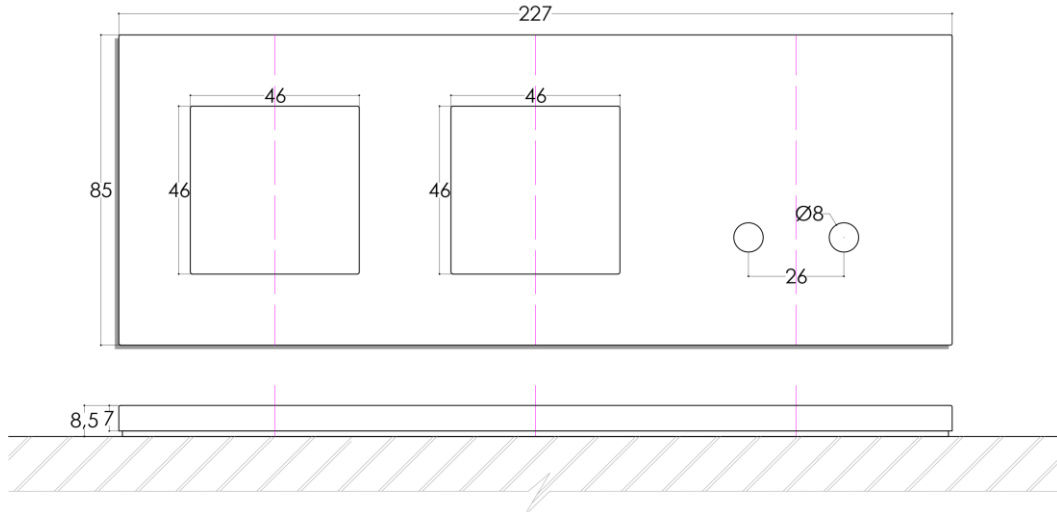

# NEVA/PARIS

## FRONT PLATE FACE AVANT

### Description

Material : full brass.

Windows opening : 2 modules + 2 modules + 2 round holes for PB (CD).

Button: round buttons.

Silicone: to reduce sound impact between buttons and face plate.

### POSITION

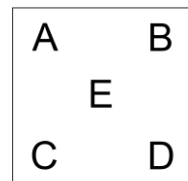

### Caractéristiques

Matière : laiton massif.

Fenêtre : 2 modules + 2 modules + 2 ouvertures rondes pour BP (CD).

Bouton: boutons ronds.

Silicone : réduit l'impacte du son entre le bouton et la face avant.

Ref.	Finish	Finition	Effect	Effet
PPA134LMH	Polished mirror brass	Laiton miroir	Shiny	Brillant
PPA134LBH	Brushed brass	Laiton brossé	Matt	Mat
PPA134LSH	Microbilled/satin brass	Laiton microbillé	Satin	Satin
PPA134VOH	Antique/old gold	Vieil or	Matt	Mat
PPA134BMH	Medium bronze	Bronze moyen	Matt	Mat
PPA134BRH	Dark bronze	Bronze noir	Shiny	Brillant
PPA134BZH	Grey bronze	Bronze gris	Matt	Mat
PPA134NMH	Polished mirror nickel	Nickel miroir	Shiny	Brillant
PPA134NBH	Brushed nickel	Nickel brossé	Matt	Mat
PPA134NSH	Microbilled/satin nickel	Nickel brossé	Matt	Mat
PPA134CHH	Polished mirror chrome	Chrome miroir	Shiny	Brillant
PPA134ROH	Brushed copper	Cuivre brossé	Matt	Mat
PPA134RAH	RAL code 9003	RAL codes 9003	Matt	Mat
PPA134ORH	24K gold	24K or	Shiny	Brillant
PPA134OMH	24K microbilled gold	microbillé 24K or	Satin	Satin